

Article number: 3213363

Description: Ortlinghaus Coupling size 63

## Measures

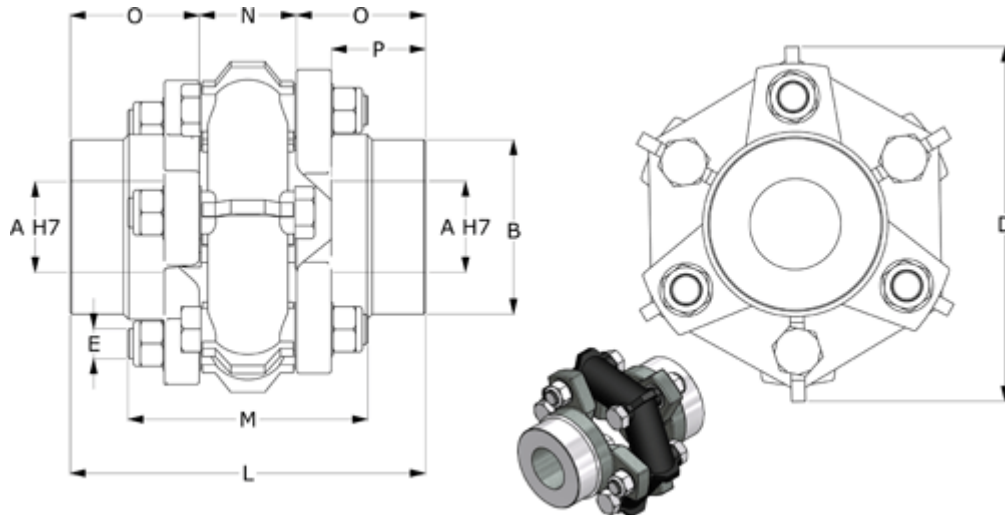

A max H7	= 95	M	= 182	Tightening torque N m	= 330
Axial displacement mm	= +/-7	Moment of inertia kg/m <sup>2</sup>	= 0.10000	Weight	= 28.0
B	= 145	N	= 78		
Bending angle	= +/-1,7	O	= 111		
C	= 210	P	= 90		
D	= 281	Radial displacement	= +/-1		
E	= M20	Standard running NM	= 1200		
L	= 300	Stress load Nm	= 3000		